



**SUNEX**<sup>®</sup>  
T O O L S

## ! WARNING

Some dust created by power sanding, sawing, grinding, drilling, and other construction activities contains chemicals known to cause cancer, birth defects or other reproductive harm. Some examples of these chemicals are:

- lead from lead-based paints,
- crystalline silica from bricks and cement and other masonry products, and
- arsenic and chromium from chemically-treated lumber.

Your risk from these exposures varies, depending on how often you do this type of work. To reduce your exposure to these chemicals: work in a well ventilated area, and work with approved safety equipment, such as those dust masks that are specially designed to filter out microscopic particles.

## SPECIFICATIONS

|                        |           |                            |                  |
|------------------------|-----------|----------------------------|------------------|
| Blows Per Minute ..... | 3,000     | Avg. Air Consumption ..... | 4 cfm            |
| Bore .....             | 11/16"    | Rec. Air Pressure .....    | 90 psig (6.2bar) |
| Stroke .....           | 2-5/8"    | Sound Level.....           | 105 dBA          |
| Air Inlet Thread ..... | 1/4" NPT  | Length .....               | 6-3/4"           |
| Hose Size .....        | 3/8" I.D. | Shipping Weight.....       | 3-1/2 Lbs.       |

## ! WARNING



ALWAYS READ  
INSTRUCTIONS  
BEFORE USING  
POWER TOOLS



ALWAYS WEAR  
SAFETY GOGGLES



WEAR HEARING  
PROTECTION



AVOID  
PROLONGED  
EXPOSURE TO  
VIBRATION

# SX275B

**MEDIUM DUTY  
AIR HAMMER**

# ! WARNING!

## FAILURE TO OBSERVE THESE WARNINGS COULD RESULT IN INJURY.

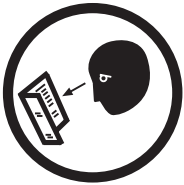

*This Instruction Manual Contains Important Safety Information.*

**READ THIS INSTRUCTION MANUAL CAREFULLY AND UNDERSTAND ALL INFORMATION BEFORE OPERATING THIS TOOL.**

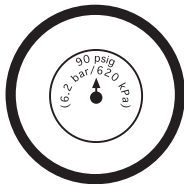

- Always operate, inspect and maintain this tool in accordance with American National Standards Institute Safety Code of Portable Air Tools (ANSI B186.1) and any other applicable safety codes and regulations.
- For safety, top performance and maximum durability of parts, operate this tool at 90 psig 6.2 bar max air pressure with 3/8" diameter air supply hose.



- Always wear impact-resistant eye and face protection when operating or performing maintenance on this tool. Always wear hearing protection when using this tool.



- High sound levels can cause permanent hearing loss. Use hearing protection as recommended by your employer or OSHA regulation.



- Keep the tool in efficient operating condition.
- Operators and maintenance personnel must be physically able to handle the bulk, weight and power of this tool.
- Air under pressure can cause severe injury. Never direct air at yourself or others. Always turn off the air supply, drain hose of air pressure and detach tool from air supply before installing, removing or adjusting any accessory on this tool, or before performing any maintenance on this tool. Failure to do so could result in injury. Whip hoses can cause serious injury. Always check for damaged, frayed or loose hoses and fittings, and replace immediately. Do not use quick detach couplings at tool. See instructions for correct set-up.



- Air powered tools can vibrate in use. Vibration, repetitive motions or uncomfortable positions over extended periods of time may be harmful to your



hands and arms. Discontinue use of tool if discomfort, tingling feeling or pain occurs. Seek medical advice before resuming use.



- Place the tool on the work before starting the tool. Do not point or indulge in any horseplay with this tool.
- Slipping, tripping and/or falling while operating air tools can be a major cause of serious injury or death. Be aware of excess hose left on the walking or work surface.



- Keep body working stance balanced and firm. Do not overreach when operating the tool.



- Anticipate and be alert for sudden changes in motion during start up and operation of any power tool.

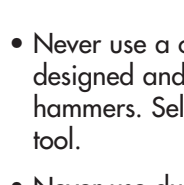

- Do not carry tool by the hose. Protect the hose from sharp objects and heat.

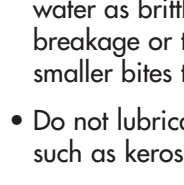

- Tool shaft may continue to rotate briefly after throttle is released. Avoid direct contact with accessories during and after use. Gloves will reduce the risk of cuts or burns.

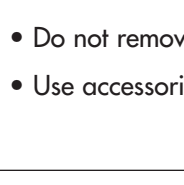

- Keep away from rotating end of tool. Do not wear jewelry or loose clothing. Scalping can occur if hair is not kept away from tool and accessories. Choking can occur if neckwear is not kept away from tool and accessories.

- Never use a chisel as a handstruck tool. They are designed and heat treated to be used only in air hammers. Select the correct shank and retainer for the tool.
- Never use dull accessories. Never cool a hot accessory in water as brittleness and early failure can result. Accessory breakage or tool damage may result from prying. Take smaller bites to avoid getting stuck.
- Do not lubricate tools with flammable or volatile liquids such as kerosene, diesel or jet fuel.
- Don't force tool beyond its rated capacity.
- Do not remove any labels. Replace any damaged labels.
- Use accessories recommended by Sunex Tools.

# SX275B

## Medium Air Hammer

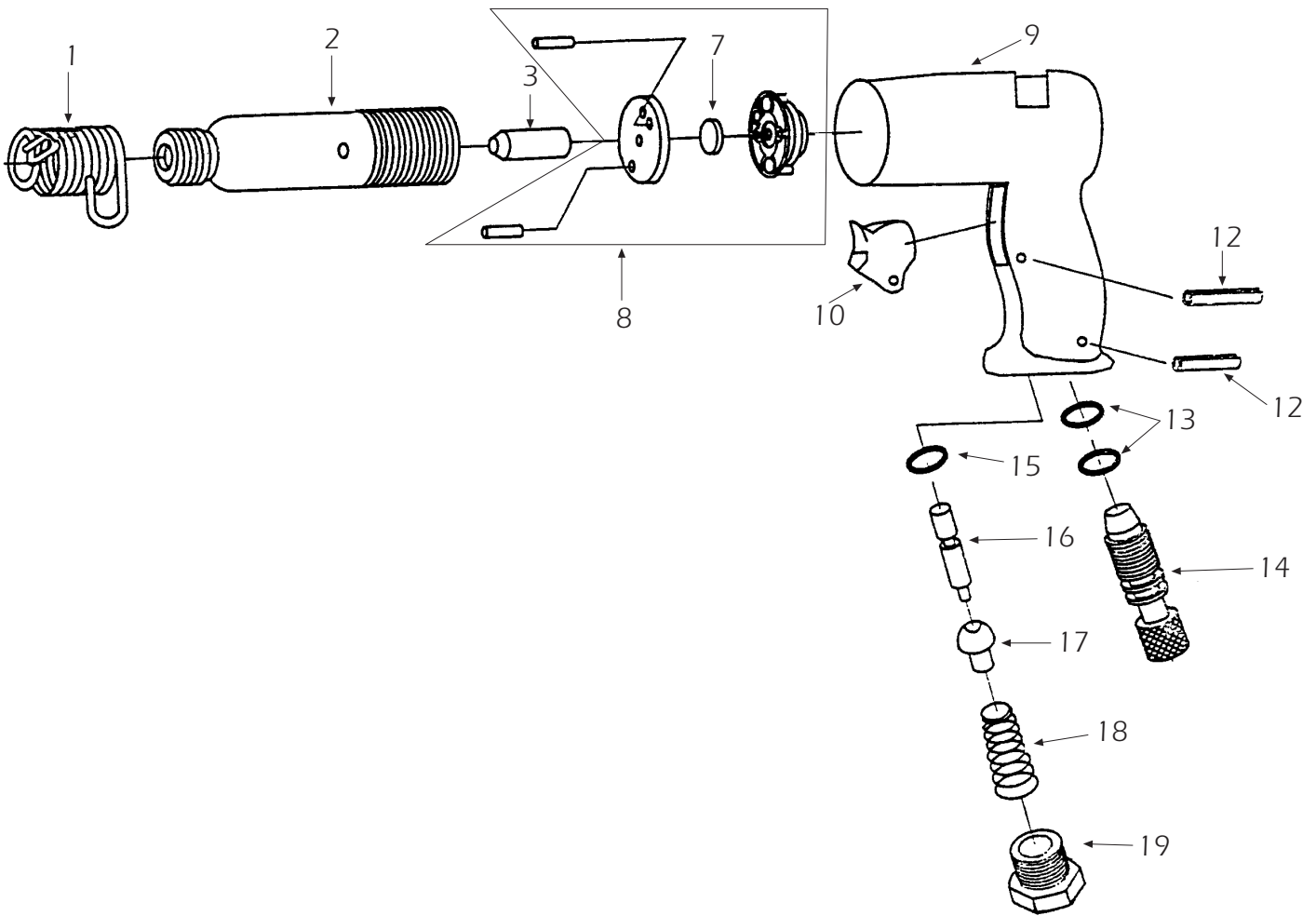

| REF. NO. | PART NO. | DESCRIPTION     | QTY. |
|----------|----------|-----------------|------|
| 1        | 87301    | Spring Retainer | 1    |
| 2        | 275B02   | Cylinder        | 1    |
| 3        | 275B03   | Piston          | 1    |
| 7        | 275B07   | Valve Disc      | 1    |
| 8        | 275B08   | Valve Assembly  | 1    |
| 9        | 275B09   | Handle          | 1    |
| 10       | 275B10   | Trigger         | 1    |
| 12       | 275B12   | Pin             | 2    |
| 13       | 275B13   | O-Ring          | 2    |
| 14       | 275B14   | Regulator       | 1    |
| 15       | 275B15   | O-Ring          | 1    |
| 16       | 275B16   | Valve Stem      | 1    |
| 17       | 275B17   | Valve Ball      | 1    |
| 18       | 275B18   | Valve Spring    | 1    |
| 19       | 275B19   | Air Inlet       | 1    |

## Operating Instructions • Warning Information • Parts Breakdown

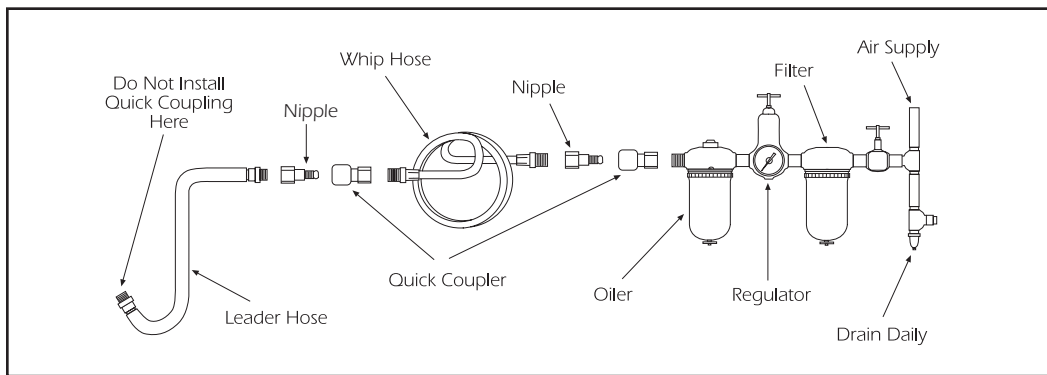

### Air Supply...

Tools of this class operate on a wide range of air pressures. It is recommended that air pressure of these tools measures 90 PSI at the tool while running free. Higher pressure (over 90 psig; 6.2 bar) raises performance beyond the rated capacity of the tool which will shorten the tool's life because of faster wear and could cause injury.

Always use clean, dry air. Dust, corrosive fumes and/or water in the air line will cause damage to the tool. Drain the air tank daily. Clean the air inlet filter screen on at least a weekly schedule. The recommended hookup procedure can be viewed in the above figure.

The air inlet used for connecting air supply, has standard 1/4" NPT. Line pressure should be increased to compensate for unusually long air hoses (over 25 feet). Minimum hose diameter should be 3/8" I.D. and fittings should have the same inside dimensions and be tightly secured.

### Lubrication...

Lubricate the air motor daily with quality air tool oil. If no air line oiler is used, run a teaspoon of oil through the tool. The oil can be squirted into the tool air inlet or into the hose at the nearest connection to the air supply, then run the tool.

### Limited Warranty...

**SUNEX INTERNATIONAL, INC. WARRANTS TO ITS CUSTOMERS THAT THE COMPANY'S SUNEX TOOLS® BRANDED PRODUCTS ARE FREE FROM DEFECTS IN WORKMANSHIP AND MATERIALS.**

Sunex International, Inc. will repair or replace its Sunex Tools® branded products which fail to give satisfactory service due to defective workmanship or materials, based upon the terms and conditions of the following described warranty plans attributed to that specific product. This product carries a ONE-YEAR warranty. During this warranty period, Sunex Tools will repair or replace at our option any part or unit which proves to be defective in material or workmanship.

#### Other important warranty information...

This warranty does not cover damage to equipment or tools arising from alteration, abuse, misuse, damage and does not cover any repairs or replacement made by anyone other than Sunex Tools or its authorized warranty service centers. The foregoing obligation is Sunex Tools' sole liability under this or any implied warranty and under no circumstances shall we be liable for any incidental or consequential damages.

**Note:** Some states do not allow the exclusion or limitation of incidental or consequential damages, so the above limitation or exclusion may not apply to you. Return equipment or parts to Sunex Tools, or an authorized warranty service center, transportation prepaid. Be certain to include your name and address, evidence of the purchase date, and description of the suspected defect.

If you have any questions about warranty service, please write to Sunex Tools. This warranty gives you specific legal rights and you may also have other rights which vary from state to state. Repair kits and replacement parts are available for many of Sunex Tools products regardless of whether or not the product is still covered by a warranty plan.

**Shipping Address:** Sunex Tools • 315 Hawkins Rd. • Travelers Rest, SC 29690

**Mailing Address:** Sunex Tools • P.O. Box 4215 • Greenville, SC 29608

### Operation...

Always place a chisel in the hammer and hold the tool down to the work before operating. Damage to the tool or the retainer may result if this precaution is not followed.

The chisel retainers are not designed for complete safety against accidental release of cutters or hammers. To avoid injury, the throttle must never be depressed unless the chisel is held firmly against the work place. When tool is not in actual use, the chisel must be removed. During operation, safety goggles should always be used to guard against flying rust and chips. When using tool, regulate the speed so that the chisel is not being driven out of the cylinder. If piston is allowed to strike the cylinder wall, internal damage will result.

To change chisel, pull back on spring hook and insert chisel. Release spring hook.

To regulate air, turn air regulator knob out for maximum air pressure and in for minimum.